

sistema oleodinamico / oildynamic system

## kit Sauna

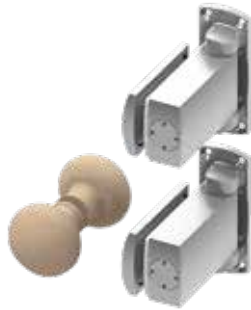

KSN8060



Alluminio / Aluminium - finiture / colors 22

Il cuore del kit è costituito dalle cerniere Biloba BT, nella speciale finitura 22, ossidazione profonda 20 micron. Il kit per l'ambiente Sauna è composto dalla 2 cerniere Biloba 8060BT in abbinamento al pomolo in legno art.5006BT. Non è previsto l'utilizzo di un profilo in quanto abitualmente la cabina è già predisposta con profili di battuta in legno.

El "corazón" del kit es hecho por las bisagras "BilobaBT" - especial acabado 22 - oxidación profunda 20 micrones. El kit de sauna es con dos bisagras "Biloba" 8060BT - en combinación al pomo de madera art.5006BT. No hay un perfil y esto depende de si la sauna ya está equipada de perfiles de madera.

The main product of this set is the hinge 8060BT, finish 22 (deep oxidation 20 micron). The set for sauna is composed of 2 Biloba hinges 8060BT and one wooden knob ref. 5006BT. As cabins are usually equipped with appropriate seals made of wood, no profile is foreseen in the set.

Hydraulische Scharniere für den Einsatz in Nassbereichen wie Duschen, Saunen und Dampfbädern. Ausgestattet mit allen Charakt Das Set Herz besteht aus den Bändern Biloba BT in der Sonderoberfläche 22 (tiefe Oxidation 20 Mikron). Der Bausatz für Saunen besteht aus 2 Bändern Biloba 8060BT und einem Holzknopf (Artikelnr. 5006BT). Gewöhnlich ist die Kabine mit Anschlagprofile aus Holz ausgerüstet, auf diesem Grund haben wir kein Profil vorgesehen.

La partie centrale de ce kit est la charnière Biloba BT, dans une finition spéciale 22, et une oxydation profonde de 20 microns. Ce système pour sauna est composé de 2 charnières Biloba 8060BT et d'une poignée en bois art.5006BT. Les cabines étant habituellement conçues en bois, aucun profil n'est prévu dans le kit.



sistema oleodinamico / oildynamic system

## kit **Bagno Turco**



**KBT8061**



Alluminio / Aluminium - finiture / colors 22

Il cuore del kit è costituito dalle cerniere Biloba BT, nella speciale finitura 22, ossidazione profonda 20 micron. Il kit per l'ambiente Bagno Turco è composto da 2 cerniere Biloba 8061BT e dai profili Espro, 2 PCC08K + 2 PCC03K entrambi da 3,2 metri, che consentono di contenere efficacemente l'uscita del vapore. Nel kit Bagno turco il pomolo in legno o il maniglione sono opzionali e la scelta è a discrezione del cliente.

El "corazón" del kit es hecho por las bisagras "BilobaBT" - especial acabado 22 - oxidación profunda 20 micrones. El kit de baño de vapor es con dos bisagras "Biloba" 8061BT y perfiles "Espro" - 2 PCC08K + 2 PCC03K de 3,2 metros, que permiten contener eficazmente la salida de vapor. En el kit baño de vapor, el pomo en madera o el tirador son a petición y la selección es a discreción del cliente.

The main product of this set is the hinge 8060BT, finish 22 (deep oxidation 20 micron). The set for steam baths is composed of 2 Biloba hinges 8061BT and Espro profiles (2 PCC08K + 2 PCC03K both in lengths of

3,2 meters). These profiles avoid steam runoff. In this set the wooden knob or the handle are optional and the choice is at complete discretion of the customer.

Das Set Herz besteht aus den Bändern Biloba BT in der Sonderoberfläche 22 (tiefe Oxidation 20 Mikron). Der Bausatz für Dampfbäder besteht aus 2 Bändern Biloba 8061BT und Espro Profilen (2 Stk PCC08K + 2 Stk PCC03K, beide mit Länge 3,2 Meter). Diese Profile vermeiden Dampfaustritt sehr gut. Bei diesem Bausatz sind Holzknopf und Türdrücker optional und die Wahl ist nach Belieben des Kunden.

La partie centrale de ce kit est la charnière Biloba BT, dans une finition spéciale 22, et une oxydation profonde de 20 microns. Ce système pour hammams est composé de 2 charnières Biloba 8060BT, et des profils Espro, 2 PCC08K + 2 PCC03K, les deux de 3,2 mètres. Arrêt à +90°. Dans le kit pour hammams le bouton de porte en bois ou la poignée sont optionnels, il appartient au client de décider.



## KSN8060

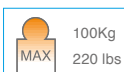
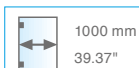
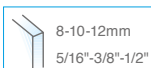

• Il kit per l'ambiente Sauna è composto da 2 cerniere Biloba 8060BT in abbinamento a pomolo in legno art.5006BT. Stop a +90°.

• El kit de sauna es con dos bisagras "Biloba" 8060BT - en combinación a pomo de madera art.5006BT. Freno a +90°.

• The sauna set comprises of : 2 Biloba hinges 8060BT, 1 pair of wooden knobs 5006BT. Stop at +90°.

• Der Bausatz für Saunen besteht aus 2 Bändern Biloba 8060BT und einem Holzknopf Artikelnr. 5006BT. Feststellung bei +90°.

• Le kit pour sauna est composé de 2 charnières Biloba 8060BT et du bouton en bois art.5006BT. Arrêt à +90°.



### Compreso



**8060BT (2X)**  
(vetro/vidrio/glass/Glas  
8-10-12mm)



**5006BT (1X)**

### Included

## KBT8061

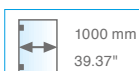
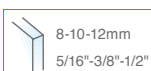

• Il kit per l'ambiente Bagno Turco è composto da 2 cerniere Biloba 8061BT e dai profili Espro, 2 PCC08K + 2 PCC03K + 2 PCC37 entrambi da 3,2 metri. Stop a +90°.

• El kit de baño de vapor es con dos bisagras "Biloba" 8061BT y perfiles "Espro" + 2 PCC08K + 2 PCC03K + 2 PCC37 de 3,2 metros. Freno a +90°.

• The steam baths set comprises of: 2 Biloba hinges 8061BT, 2 Espro profiles PCC08K, 2 Espro profiles PCC03K + 2 PCC37. Espro profiles are both in lengths of 3.2meters. Stop at +90°.

• Der Bausatz für Dampfbäder besteht aus 2 Bändern Biloba 8061BT und je zwei Espro Profilen PCC08K und PCC03K + 2 PCC37, beide 3,2 Meter lang. Feststellung bei +90°.

• Le kit pour hammams est composé de 2 charnières Biloba 8061BT et des profils Espro, 2 PCC08K + 2 PCC03K, de 3,2 mètres chacun. Arrêt à +90°.

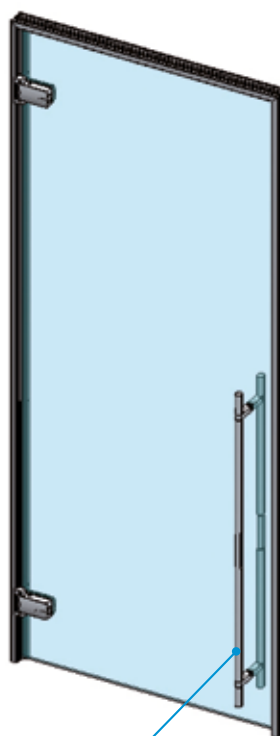

OPTIONAL

### Compreso



**8061BT (2X)**  
(vetro/vidrio/glass/Glas  
8-10-12mm)



**PCC03K/3 (2X)**



**PCC08K/3 (2X)**



**PCC37 (2X)**

### Included

# KBT8061

## DETTAGLIO PROFILI - DETAIL OF PROFILES

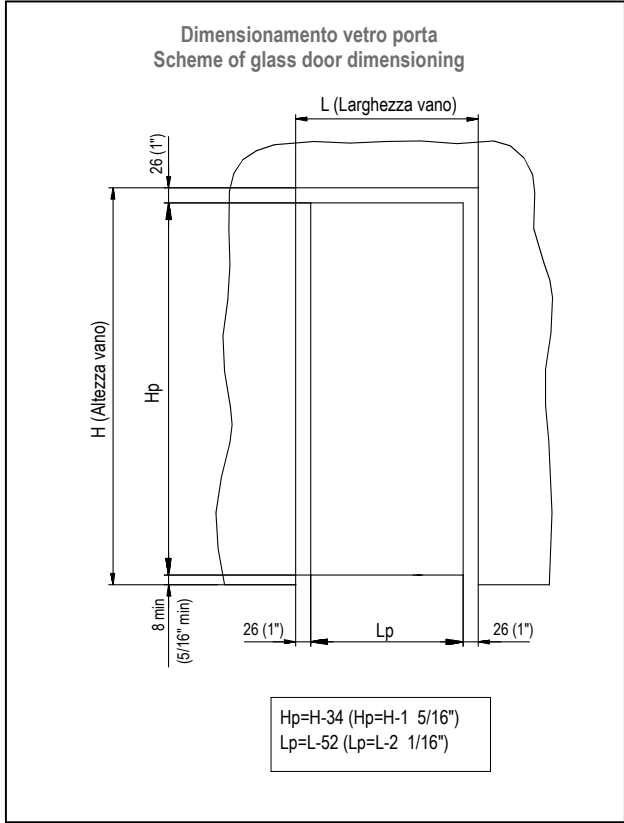
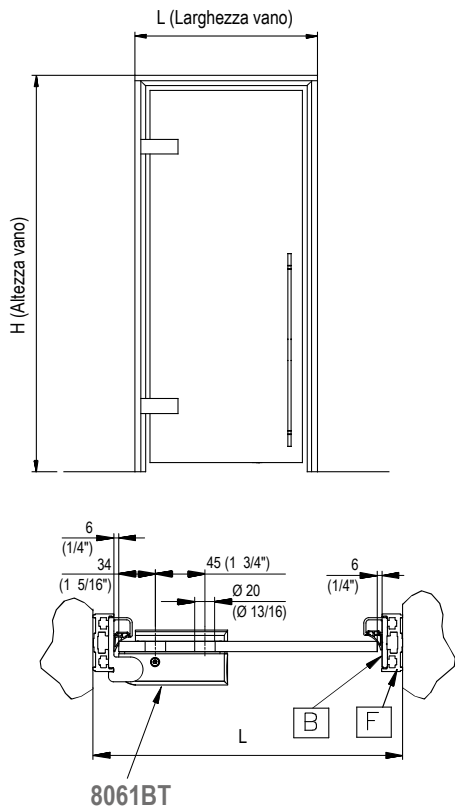

## Formule di taglio profili - Fórmula de corte de los perfiles - Profiles cut formula - Profilansicht - Formule de coupe des profils

### PCC08

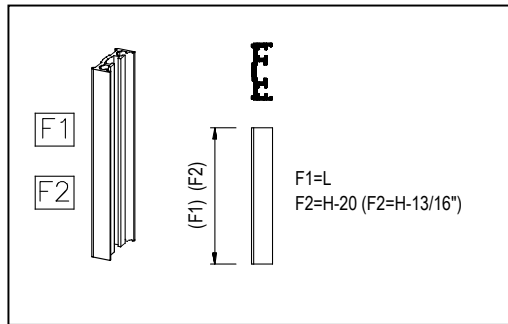
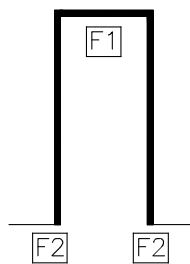

### PCC03

