

FLUIDO+



We Build the Invisible

colcomgroup.it

follow us on [f](#) [y](#) [t](#) [in](#)

webuildtheinvisible.com

follow us on [f](#) [i](#) [y](#) [in](#)



We Build the Invisible

Colcom è leader mondiale nel segmento di mercato di fascia alta nella fornitura di soluzioni architettoniche in vetro per esterni e interni. La leadership nella fascia di alto livello è garantita anche da brevetti innovativi.

Colcom is a world leader in the high-end segment of glass architectural solutions for indoor and outdoor applications. Our leadership in the high-end segment is guaranteed by innovative patents.

Sistemi scorrevoli invisibili e compatti

*Invisibile and compact
sliding systems*



FLUIDO+

COMPATTO, VERSATILE COMPACT, VERSATILE

Fluido+ 70, 110 e 150 sono i nuovi sistemi scorrevoli compatti per porte in vetro temperato. Le pareti buie appartengono al passato, le esigenze di oggi sono trasparenza e spazi ampi. La meccanica indistruttibile dei sistemi Fluido+ si fonde perfettamente con il design moderno, garantendo sicurezza, privacy e luminosità. Progettato per soddisfare le richieste del mercato, è adatto per applicazioni: a muro, a soffitto e falso soffitto. Nella versione a falso soffitto il meccanismo è completamente nascosto.

Fluido+ 70, 110 and 150 are our latest compact sliding systems for tempered glass doors. Dark walls belong to the past: modern needs are clarity and ample spaces. The resistant mechanics of Fluido+ systems blends perfectly with their modern design, allowing security, privacy and brightness. Conceived to respond market needs, they are suitable for wall, ceiling and false ceiling installations. In the false ceiling version, the sliding mechanism is completely hidden.

- Nuovo sistema di chiusura progressiva - CPCS
- Antishock disponibile
- Regolazione frontale dell'anta semplificata e rapida
- Portata fino 150 kg
- Aggancio rapido tra veletta e binario
- Disponibile la versione per porte in legno

- New CPCS progressive closing system
- Antishock available
- Front adjustment of the door: simple and quick
- Capacity up to 150 kg
- Quick coupling of sliding rail and cover
- Available for wooden doors

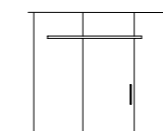

A VETRO
On glass

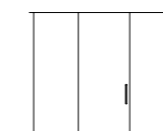

A FALSO SOFFITTO
False ceiling

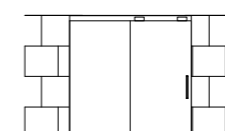

TRA PARETI
Between walls





Colcom Progressive Closing System

FUNZIONALE, SICURO

FUNCTIONAL, SECURE

Fluido+ integra il nuovo sistema Colcom di chiusura progressiva “Colcom Progressive Closing System”(CPCS); combinando il design minimale alla massima funzionalità. E’ l’accessorio che permette una chiusura automatica e graduale della porta.

Il sistema antishock integrato rallenta la corsa della porta nell’ultimo tratto di chiusura, evitando situazioni di pericolo. Non modifica l’estetica della porta poiché è invisibile dall’esterno; può essere applicato anche su ante in legno. Si installa facilmente e velocemente in ambienti sia residenziali che commerciali.

Fluido+ features the new closing system “Colcom Progressive Closing System” (CPCS); combining minimal design and maximum functionality. The accessory allows an automatic and gradual closing of the door.

The integrated antishock system slows the movement of the door in the last section, avoiding dangerous situation. It does not modify the door’s aesthetics because it is invisible from outside; can be mounted on wooden doors as well. The system is easily and quickly installed in both commercial and residential environments.

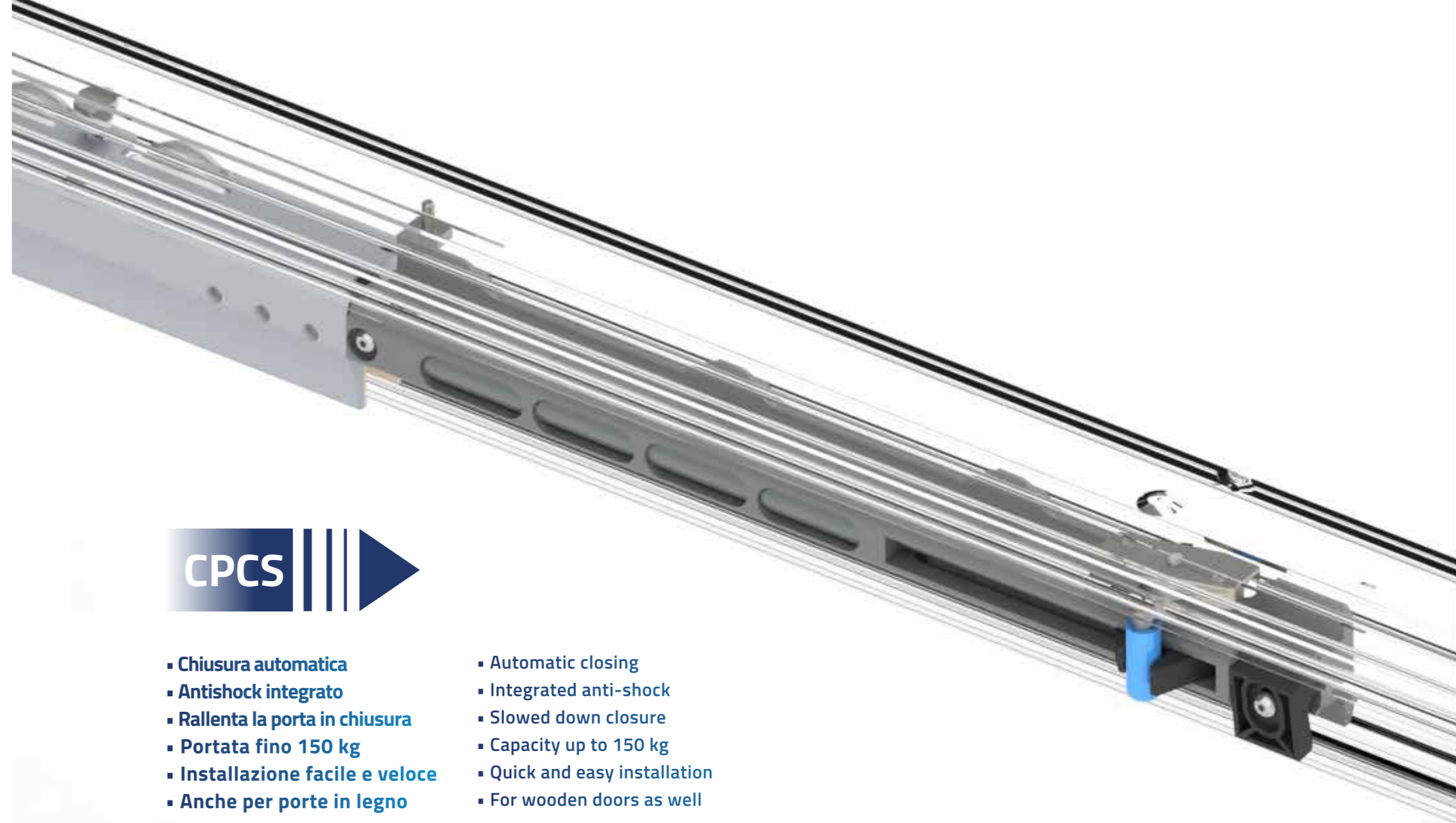

CPCS

- Chiusura automatica
- Antishock integrato
- Rallenta la porta in chiusura
- Portata fino 150 kg
- Installazione facile e veloce
- Anche per porte in legno
- Automatic closing
- Integrated anti-shock
- Slowed down closure
- Capacity up to 150 kg
- Quick and easy installation
- For wooden doors as well

FLUIDO+ 70

CARATTERISTICHE CHARACTERISTICS

PESO PER PORTA - WEIGHT FOR DOOR: 70kg

VETRO - GLASS: 8÷12mm

LEGNO - WOOD: 28÷50mm

LUNGHEZZA - LENGHT: 2, 3, 4 e 6 metri

CARATTERISTICHE DURABILITY

100.000 CICLI - GRADO 6

FINITURE COLORS



02

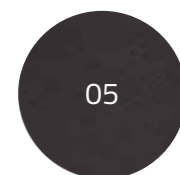

05



13 PVD



Installazioni porte in vetro e caratteristiche tecniche profili
Glass doors installation and profiles technical characteristics

SCORREVOLE A SOFFITTO
Sliding on Ceiling

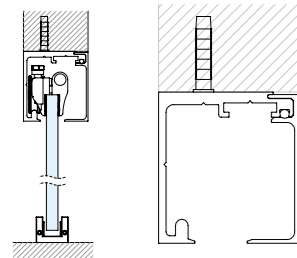
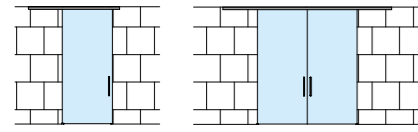

60 x 55.5 mm

SCORREVOLE A PARETE
Sliding on Wall

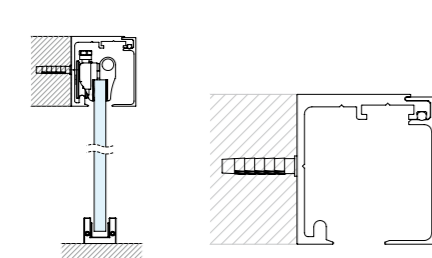
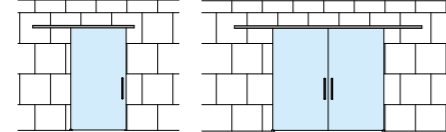

60 x 55.5 mm

SCORREVOLE SU VETRO FISSO
Sliding on Sidelight

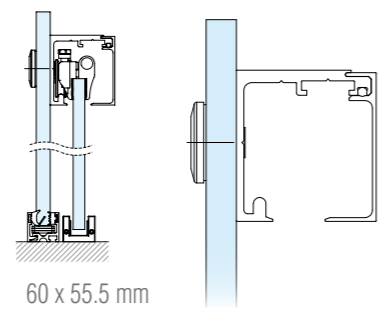
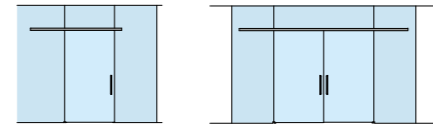

60 x 55.5 mm

SCORREVOLE A SOFFITTO CON FISSO
Sliding on Ceiling with Sidelight

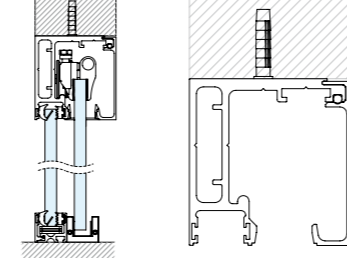
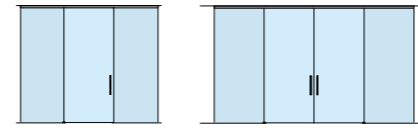

72 x 69.5 mm

INSTALLAZIONE CON SUPPORTO A PARETE
Installation with Supports on Wall

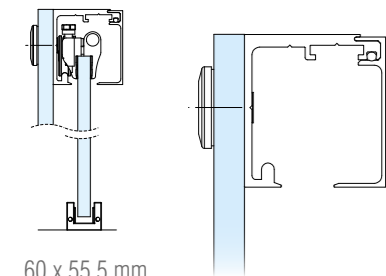
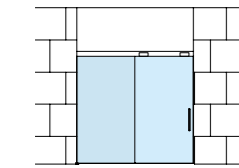

60 x 55.5 mm

INSTALLAZIONE CON SUPPORTO A PARETE
Installation with Supports on Wall

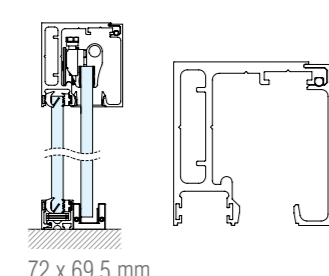
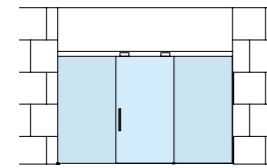

72 x 69.5 mm

SCORREVOLE A FALSO SOFFITTO
Sliding on False Ceiling

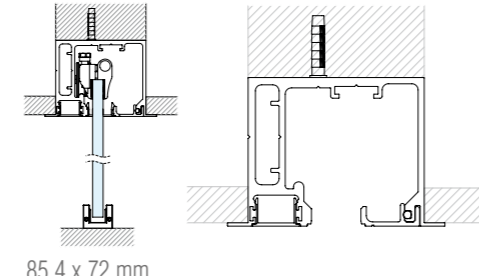
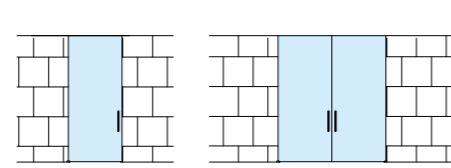

85,4 x 72 mm

SCORREVOLE A FALSO SOFFITTO CON FISSO
Sliding on False Ceiling with Sidelight

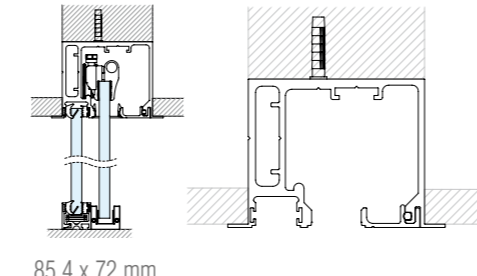
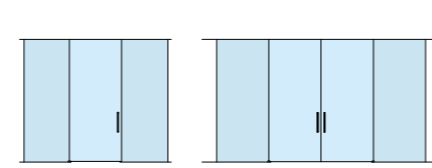

85,4 x 72 mm

Installazioni porte in legno e caratteristiche tecniche profili
Wooden doors installation and profiles technical characteristics

SCORREVOLE A SOFFITTO
Sliding on Ceiling

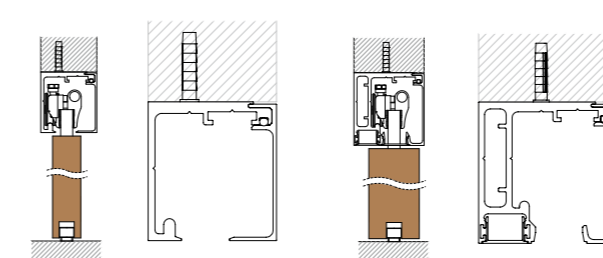
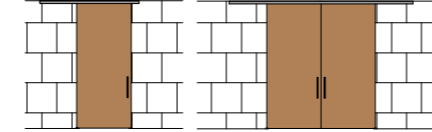

• < 40mm

60 x 55.5 mm

• > 40mm

72 x 69.5 mm

SCORREVOLE A PARETE
Sliding on Wall

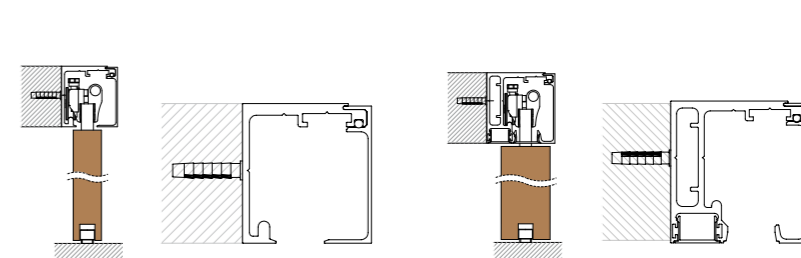
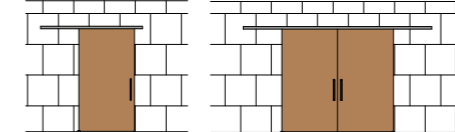

• < 40mm

60 x 55.5 mm

• > 40mm

72 x 69.5 mm

SCORREVOLE A SOFFITTO CON FISSO
Sliding on Ceiling with Sidelight

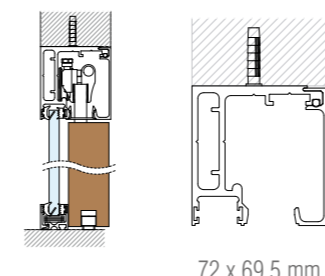
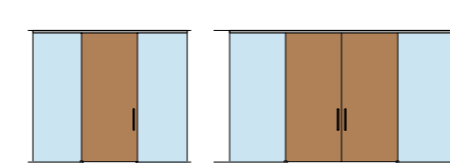

72 x 69.5 mm



Caratteristiche Tecniche

Technical features

 PORTATA Weight	70kg per porta / for door 154lbs
 SPESORE VETRO Glass thickness	8 ÷ 12 mm 5/16" to 1/2"
 SPESORE PORTA IN LEGNO Wooden door thickness	28 ÷ 50 mm 1 1/8" to 1 15/16"
 REGOLAZIONE IN ALTEZZA Height adjustment	6 mm 1/4"
 DISTANZA A PARETE Wall distance	19 mm 3/4"
 DISTANZA TRA ANTA E VETRO FISSO Distance between door and sidelight	14.2 ÷ 16.2 mm 9/16" to 5/8"

 INSTALLAZIONE A VETRO Glass installation	✓
 INSTALLAZIONE A FALSO SOFFITTO False ceiling installation	✓
 INSTALLAZIONE TRA PARETI Installation between walls	✓

 SOFTCLOSE Soft close	Doppio / Double		
 DIMENSIONI MINIME (doppio Softclose) Minimum dimensions (double soft close)	660 mm 26"		
 RETAINER MECCANICO Mechanical retainer	Doppio / Double		
 DIMENSIONI MINIME (doppio Retainer) Minimum dimensions (double Retainer)	450 mm 17 11/16"		
 FINITURE Finishes	02 Ossidato naturale Natural oxidized	05 Ossidato nero Black oxidized	13 PVD simil inox similar PVD stainless steel

 **CERTIFICAZIONE DURABILITÀ**
CICLI CORROSIONE
Durability certification
Corrosion cycles

DURABILITÀ (100.000 Cicli) Durability (100.000 Cycles)
PESO DELLA PORTA (da 51 a 100 kg) Door mass (from 51 up to 100 kg)
SICUREZZA (Grado 1 per tutti gli scorrevoli) Safety (All sliding must be grade 1)
RESISTENZA ALLA CORROSIONE (Alta resistenza) Corrosion resistance (High resistance)
CATEGORIA DELLA PORTA (Porta scorrevole) Category of door (Sliding door)
FRIZIONE INIZIALE VALORE MASSIMO CONSENTITO (40N) Initial friction maximum permitted value (40N)

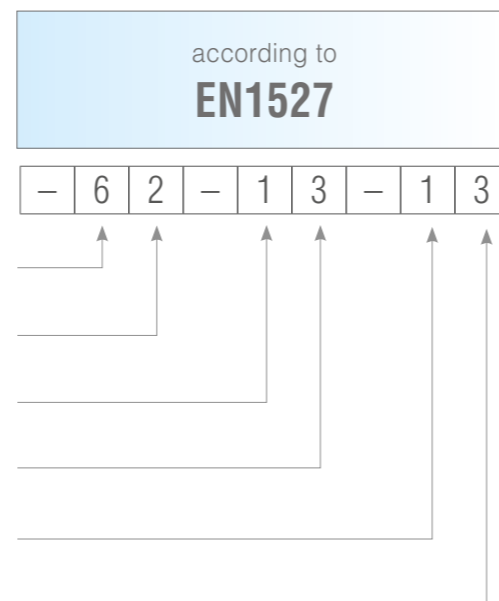

Configurazioni kit

Configurations kit

KB070CS0/2 KB070CS0/3

- Kit scorrevole parete/soffitto con doppio soft-close.
- Sliding wall / ceiling kit with double soft-close

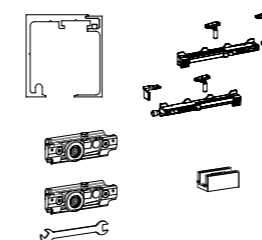

KB070CM0/2 KB070CM0/3

- Kit scorrevole parete/soffitto con retainer e stop meccanico.
- Sliding wall / ceiling kit with retainer and mechanical stop

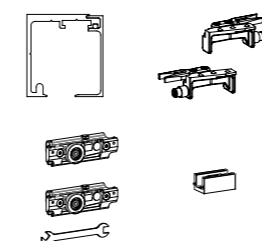

KB070SS0/2 KB070SS0/3

- Kit scorrevole su vetro fisso con doppio soft-close.
- Sliding kit on fixed glass with double soft-close

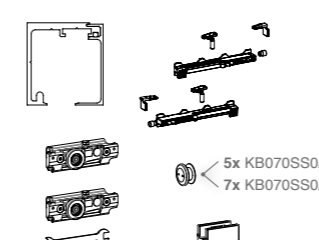

KB070SM0/2 KB070SM0/3

- Kit scorrevole su vetro fisso con retainer e stop meccanico.
- Sliding kit on fixed glass with retainer and mechanical stop

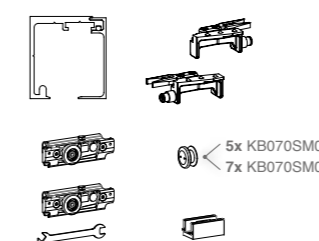

KB070FS0/2 KB070FS0/3

- Kit scorrevole a soffitto con fisso, con doppio soft-close.
- Fixed sliding ceiling kit with double soft-close

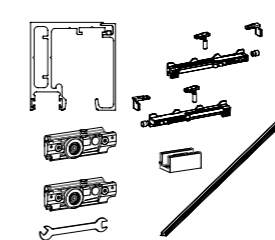

KB070FM0/2 KB070FM0/3

- Kit scorrevole a soffitto con fisso, con retainer e stop meccanico.
- Sliding ceiling kit with fixed, with retainer and mechanical stop

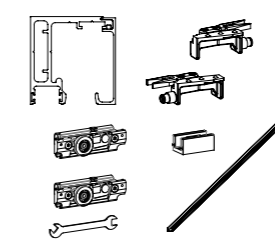

Profili

Profiles

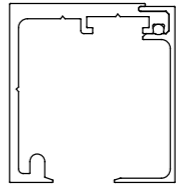
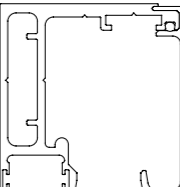
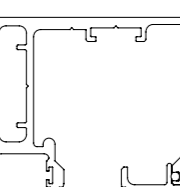
	• Profili per scorrevole - fissaggio a soffitto/parete. Anche per porte in legno < 40mm	B110EK00/2	2 m
	• Profiles for sliders - fixed on ceiling/wall. Anche per porte in legno < 40mm	B110EK00/3	3 m
		B110EK00/4	4 m
		B110EK00/6	6 m
	• Profili per scorrevole - fissaggio a soffitto con vetro fisso. - fissaggio a soffitto con fisso per porta in legno - fissaggio a parete per porta in legno > 40mm	B110EK01/2	2 m
	• Profiles for sliders - fixed on ceiling with fixed glass - fissaggio a soffitto con fisso per porta in legno - fissaggio a parete per porta in legno > 40mm	B110EK01/3	3 m
		B110EK01/4	4 m
		B110EK01/6	6 m
	• Profili per scorrevole - fissaggio a falso soffitto - fissaggio a falso soffitto con vetro fisso.	* B110EK02/2	2 m
	• Kit profiles for sliders - fixed on false ceiling - fixed on false ceiling with fixed glass	* B110EK02/3	3 m
		* B110EK02/4	4 m
		* B110EK02/6	6 m

* Disponibile da marzo 2021 - Available from March 2021

Kit pinze Clamps kit



B070EK10

- Kit coppia pinze con chiave
- Kit with Clamps and Key



B150EK3NN

- Kit coppia Retainer. Stop meccanico
- Kit with pair of mechanical stops



B070EK3SS

- Kit coppia Soft Close CPCS
- Kit with Soft Close CPCS pair



Tappi Caps



B110EP73

- Coppia di tappi
- Pair of caps



B110EP74

- Coppia di tappi forati
- Pair of perforated caps



B110EP75

- Coppia di tappi per versione con fisso laterale
- Pair of caps for model with side fixed glass



B110EP76

- Coppia di tappi forati per versione con fisso laterale
- Pair of perforated caps for model with side fixed glass

Accessori Accessories



B110EP64

- Spessore per Veletta - senza vetro fisso
- Spacer for track - without fixed glass



B110EP77

- Coppia supporti laterali
- Pair of side fittings



B150EP48

- Tassello di collegamento per vetro fisso
- Splice connector for fixed glass



BF50

- Guida a terra.
- Floor Guide



B150EP85

- Kit accessorio per porte in legno
- Accessory kit for wooden doors



BF70

- Borchia per fissaggio barra a vetro
- Fitting for securing track to glassbar



B150EP27

- Perno per porte battenti da applicare ad estrusi Fluido+
- Spindle for swing doors, to be applied to Fluido+ profiles



B150EP45

- Copertura lato fisso
- Cover fixed panel



B150EP46

- Copertura lato porta
- Cover door side

FLUIDO+ 110

CARATTERISTICHE CHARACTERISTICS

PESO PER PORTA - WEIGHT FOR DOOR: 110kg

VETRO - GLASS: 10÷12.76mm

LEGNO - WOOD: 28÷50mm

LUNGHEZZA - LENGHT: 2, 3, 4 e 6 metri

CARATTERISTICHE DURABILITY

100.000 CICLI - GRADO 6

FINITURE COLORS

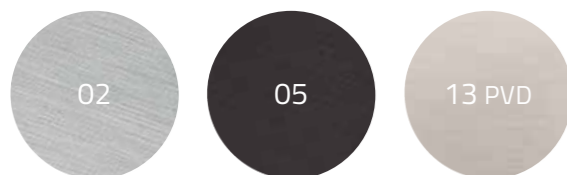

Installazioni porte in vetro e caratteristiche tecniche profili
Glass doors installation and profiles technical characteristics

SCORREVOLE A SOFFITTO
Sliding on Ceiling

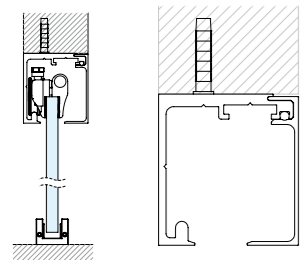
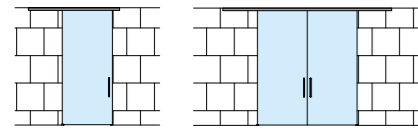

60 x 55.5 mm

SCORREVOLE A PARETE
Sliding on Wall

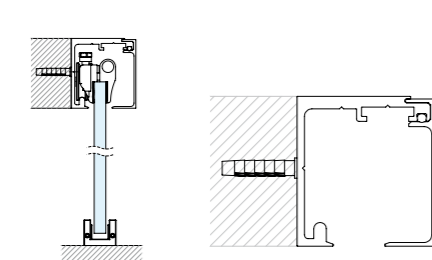
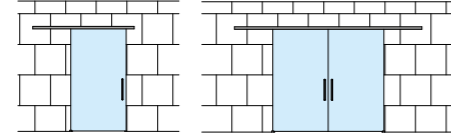

60 x 55.5 mm

SCORREVOLE SU VETRO FISSO
Sliding on Sidelight

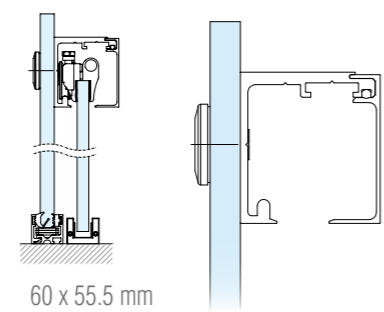
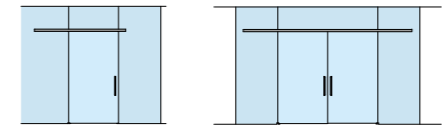

60 x 55.5 mm

SCORREVOLE A SOFFITTO CON FISSO
Sliding on Ceiling with Sidelight

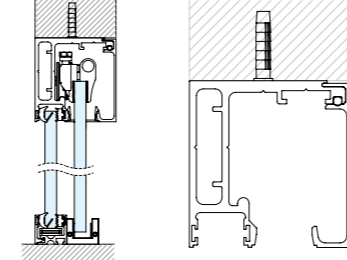
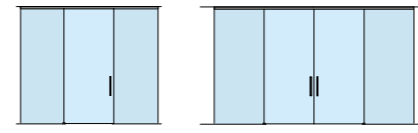

72 x 69.5 mm

SCORREVOLE A FALSO SOFFITTO
Sliding on False Ceiling

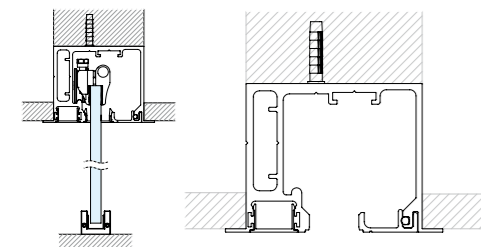
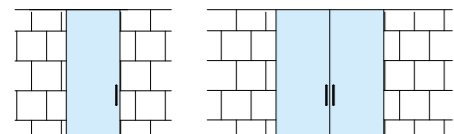

85,4 x 72 mm

SCORREVOLE A FALSO SOFFITTO CON FISSO
Sliding on False Ceiling with Sidelight

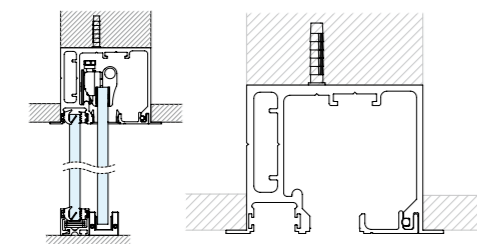
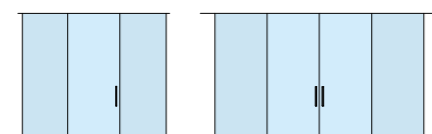

85,4 x 72 mm

Installazioni porte in legno e caratteristiche tecniche profili
Wooden doors installation and profiles technical characteristics

SCORREVOLE A SOFFITTO
Sliding on Ceiling

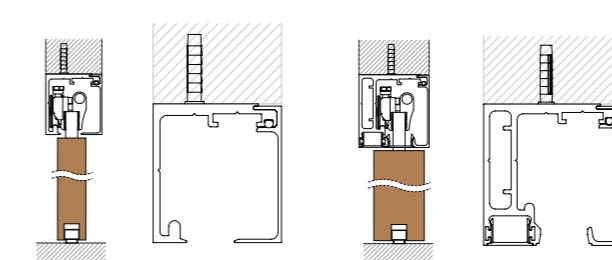
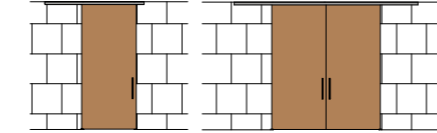

• < 40mm

60 x 55.5 mm

• > 40mm

72 x 69.5 mm

SCORREVOLE A PARETE
Sliding on Wall

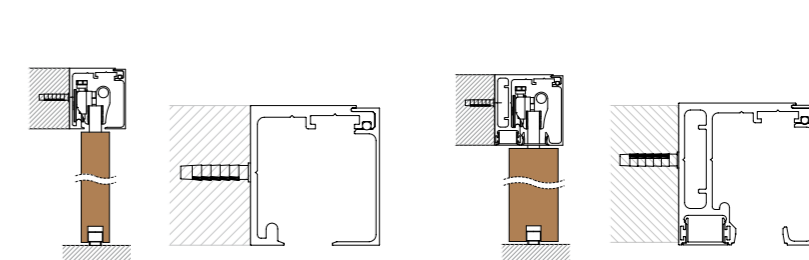
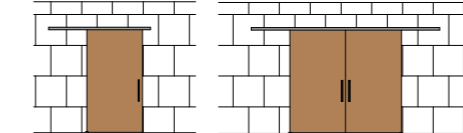

• < 40mm

60 x 55.5 mm

• > 40mm

72 x 69.5 mm

SCORREVOLE A SOFFITTO CON FISSO
Sliding on Ceiling with Sidelight

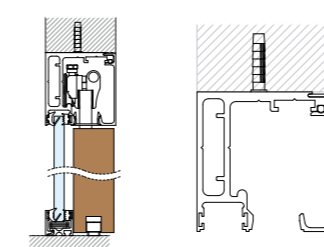
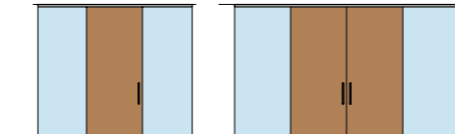

















72 x 69.5 mm



Caratteristiche Tecniche

Technical features

 PORTATA Weight	110kg per porta / for door 242lbs		
 SPESORE VETRO Glass thickness	10 ÷ 12.76 mm 3/8" to 1/2"		
 SPESORE PORTA IN LEGNO Wooden door thickness	28 ÷ 50 mm 1 1/8" to 1 15/16"		
 REGOLAZIONE IN ALTEZZA Height adjustment	6 mm 1/4"		
 DISTANZA A PARETE Wall distance	20 mm 13/16"		
 DISTANZA TRA ANTA E VETRO FISSO Distance between door and sidelight	14.8 ÷ 16.2 mm 9/16" to 5/8"		
 INSTALLAZIONE A VETRO Glass installation	✓		
 INSTALLAZIONE A FALSO SOFFITTO False ceiling installation	✓		
 INSTALLAZIONE TRA PARETI Installation between walls	✓		
 SOFTCLOSE Soft close	Doppio / Double		
 DIMENSIONI MINIME (doppio antishock) Minimum dimensions (double antishock)	922 mm 36 1/4"		
 ANTISHOCK Antishock	Doppio / Double		
 DIMENSIONI MINIME (doppio Softclose) Minimum dimensions (double soft close)	700 mm 27 9/16"		
 RETAINER MECCANICO Mechanical retainer	Doppio / Double		
 DIMENSIONI MINIME (doppio Retainer) Minimum dimensions (double Retainer)	700 mm 27 9/16"		
 FINITURE Finishes	02 Ossidato naturale Natural oxidized	05 Ossidato nero Black oxidized	13 PVD simil inox similar PVD stainless steel



**CERTIFICAZIONE DURABILITÀ
CICLI CORROSIONE**
Durability certification
Corrosion cycles

DURABILITÀ (100.000 Cicli)
Durability (100.000 Cycles)

PESO DELLA PORTA (da 101 a 330 kg)
Door mass (from 101 up to 330 kg)

SICUREZZA (Grado 1 per tutti gli scorrevoli)
Safety (All sliding must be grade 1)

RESISTENZA ALLA CORROSIONE (Alta resistenza)
Corrosion resistance (High resistance)

CATEGORIA DELLA PORTA (Porta scorrevole)
Category of door (Sliding door)

FRIZIONE INIZIALE VALORE MASSIMO CONSENTITO (4% della massa)
Initial friction maximum permitted value (4% of the mass)

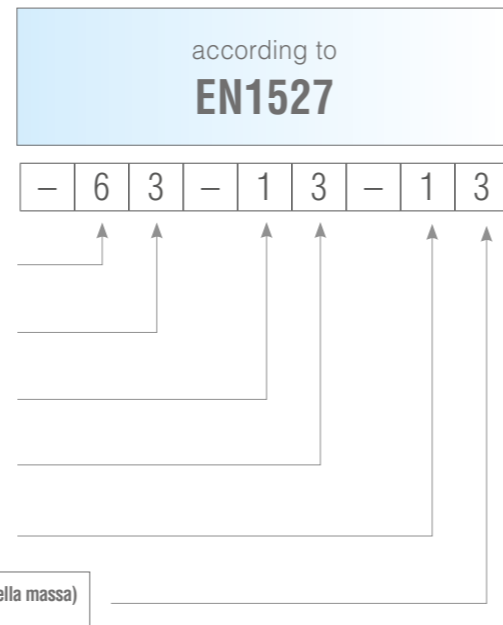

Configurazioni kit

Configurations kit

KB110CS0/2 KB110CS0/3

• Kit scorrevole parete/soffitto con doppio soft-close.

• Sliding wall / ceiling kit with double soft-close

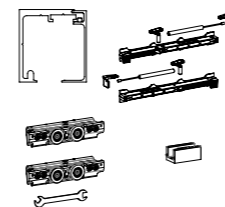

KB110CM0/2 KB110CM0/3

• Kit scorrevole parete/soffitto con retainer e stop meccanico.

• Sliding wall / ceiling kit with retainer and mechanical stop

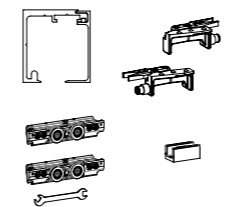

KB110CA0/2 KB110CA0/3

• Kit scorrevole parete/soffitto con retainer e antishock.

• Sliding wall / ceiling kit with retainer and Antishock

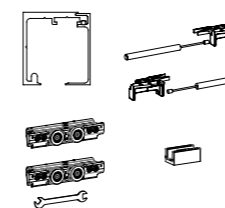

KB110SS0/2 KB110SS0/3

• Kit scorrevole su vetro fisso con doppio soft-close.

• Sliding kit on fixed glass with double soft-close

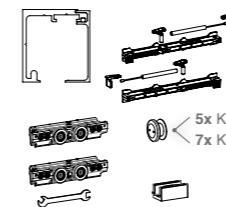

KB110SM0/2 KB110SM0/3

• Kit scorrevole su vetro fisso con retainer e stop meccanico.

• Sliding kit on fixed glass with retainer and mechanical stop

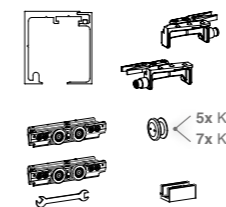

KB110SA0/2 KB110SA0/3

• Kit scorrevole su vetro fisso con retainer e antishock.

• Sliding kit on fixed glass with retainer and Antishock

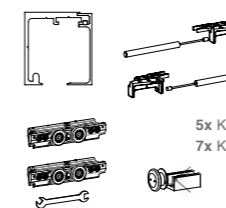

KB110FS0/2 KB110FS0/3

• Kit scorrevole a soffitto con fisso, con doppio soft-close.

• Fixed sliding ceiling kit with double soft-close

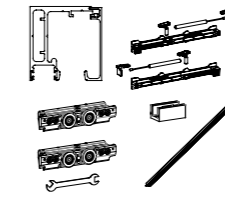

KB110FM0/2 KB110FM0/3

• Kit scorrevole a soffitto con fisso, con retainer e stop meccanico.

• Sliding ceiling kit with fixed, with retainer and mechanical stop

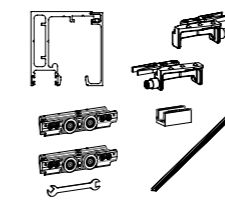

KB110FA0/2 KB110FA0/3

• Kit scorrevole a soffitto con fisso, con retainer e antishock.

• Sliding ceiling kit with fixed, with retainer and Antishock

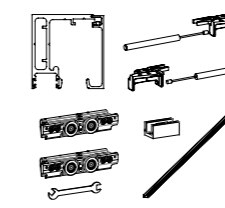

Profili

Profiles

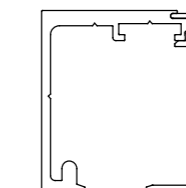

• Profili per scorrevole
- fissaggio a soffitto/parete.
Anche per porte in legno < 40mm

• Profiles for sliders
- fixed on ceiling/wall.
Anche per porte in legno < 40mm

B110EK00/2 2 m

B110EK00/3 3 m

B110EK00/4 4 m

B110EK00/6 6 m

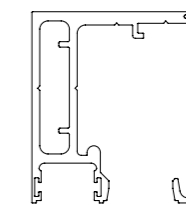

• Profili per scorrevole
- fissaggio a soffitto con vetro fisso.
- **fissaggio a soffitto con fisso per porta in legno**
- **fissaggio a parete per porta in legno > 40mm**

• Profiles for sliders
- fixed on ceiling with fixed glass
- **fissaggio a soffitto con fisso per porta in legno**
- **fissaggio a parete per porta in legno > 40mm**

B110EK01/2 2 m

B110EK01/3 3 m

B110EK01/4 4 m

B110EK01/6 6 m

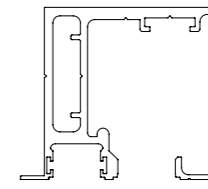

• Profili per scorrevole
- fissaggio a falso soffitto
- fissaggio a falso soffitto con vetro fisso.

• Kit profiles for sliders
- fixed on false ceiling
- fixed on false ceiling with fixed glass

* **B110EK02/2** 2 m

* **B110EK02/3** 3 m

* **B110EK02/4** 4 m

* **B110EK02/6** 6 m

* Disponibile da marzo 2021 - Available from March 2021

Kit pinze Clamps kit



B110EK10

- Kit coppia pinze con chiave
- Kit with Clamps and Key



B150EK3NN

- Kit coppia Retainer. Stop meccanico
- Kit with pair of mechanical stops



B150EK3AA

- Kit coppia Retainer + Antishock
- Kit with pair of mechanical stops and anti-shock feature



B110EK3SS

- Kit coppia Soft Close CPCS
- Kit with Soft Close CPCS pair



Tappi Caps



B110EP73

- Coppia di tappi
- Pair of caps



B110EP74

- Coppia di tappi forati
- Pair of perforated caps



B110EP75

- Coppia di tappi per versione con fisso laterale
- Pair of caps for model with side fixed glass



B110EP76

- Coppia di tappi forati per versione con fisso laterale
- Pair of perforated caps for model with side fixed glass

Accessori Accessories



B110EP64

- Spessore per Veletta - senza vetro fisso
- Spacer for track - without fixed glass



B110EP77

- Coppia supporti laterali
- Pair of side fittings



B150EP48

- Tassello di collegamento per vetro fisso
- Splice connector for fixed glass



BF50

- Guida a terra.
- Floor Guide



B150EP85

- Kit accessorio per porte in legno
- Accessory kit for wooden doors



BF70

- Borchia per fissaggio barra a vetro
- Fitting for securing track to glassbar



B150EP27

- Perno per porte battenti da applicare ad estrusi Fluido+
- Spindle for swing doors, to be applied to Fluido+ profiles

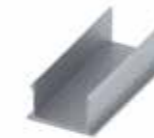

B150EP45

- Copertura lato fisso
- Cover fixed panel

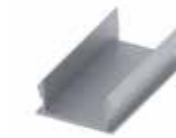

B150EP46

- Copertura lato porta
- Cover door side

FLUIDO+ 150

CARATTERISTICHE CHARACTERISTICS

PESO PER PORTA - WEIGHT FOR DOOR: 150kg

VETRO - GLASS: 10÷14mm

LEGNO - WOOD: 28÷50mm

LUNGHEZZA - LENGHT: 2, 3, 3.2, 4 e 6 metri

CARATTERISTICHE DURABILITY

100.000 CICLI - GRADO 6

FINITURE COLORS



02

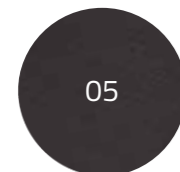

05



13 PVD



Installazioni porte in vetro e caratteristiche tecniche profili

Glass doors installation and profiles technical characteristics

SCORREVOLE A SOFFITTO
Sliding on Ceiling

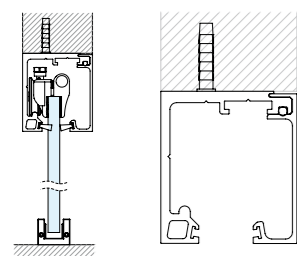
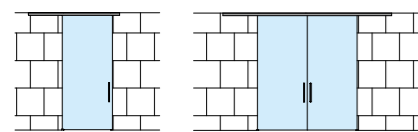

67 x 60 mm

SCORREVOLE A PARETE
Sliding on Wall

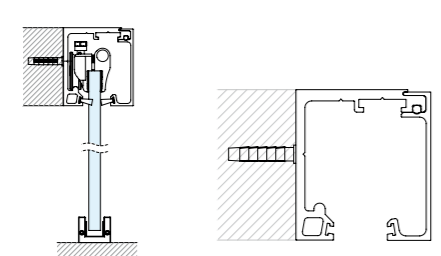
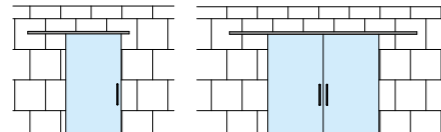

67 x 60 mm

SCORREVOLE SU VETRO FISSO
Sliding on Sidelight

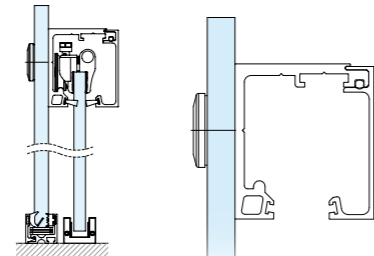
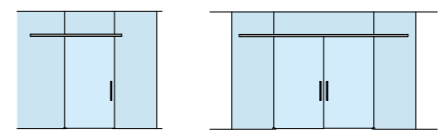

67 x 60 mm

SCORREVOLE A SOFFITTO CON FISSO
Sliding on Ceiling with Sidelight

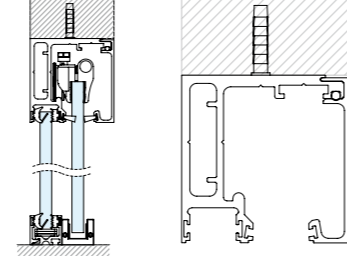
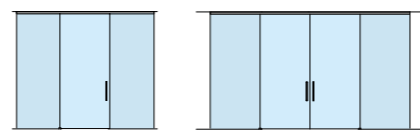

72 x 72 mm

SCORREVOLE A FALSO SOFFITTO
Sliding on False Ceiling

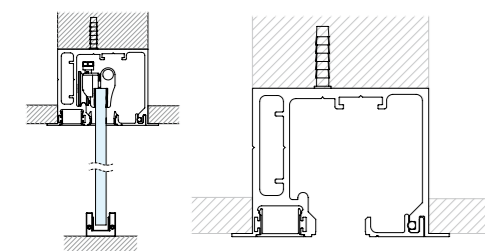
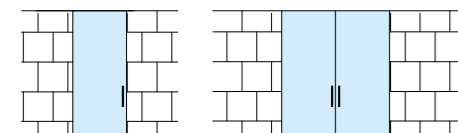

85,4 x 72 mm

SCORREVOLE A FALSO SOFFITTO CON FISSO
Sliding on False Ceiling with Sidelight

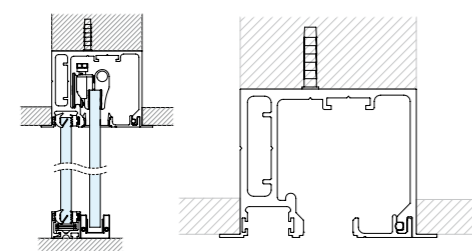
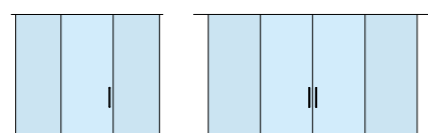

85,4 x 72 mm

Installazioni porte in legno e caratteristiche tecniche profili

Wooden doors installation and profiles technical characteristics

SCORREVOLE A SOFFITTO
Sliding on Ceiling

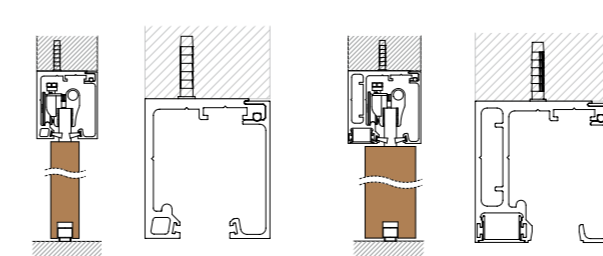
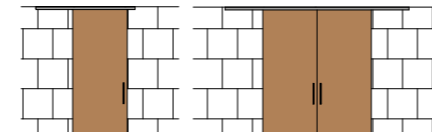

• < 40mm

67 x 70 mm

• > 40mm

72 x 72 mm

SCORREVOLE A PARETE
Sliding on Wall

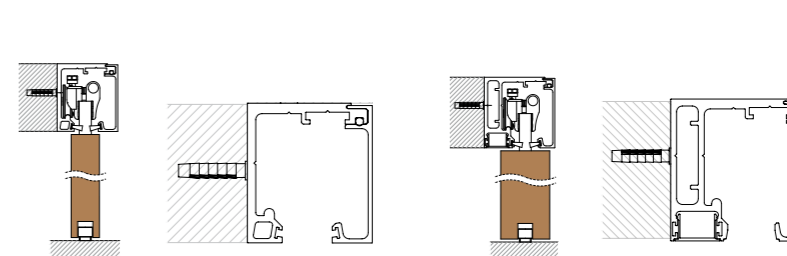
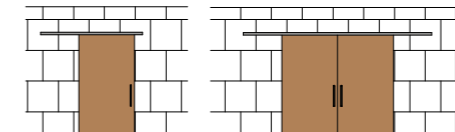

• < 40mm

67 x 70 mm

• > 40mm

72 x 72 mm

SCORREVOLE A SOFFITTO CON FISSO
Sliding on Ceiling with Sidelight

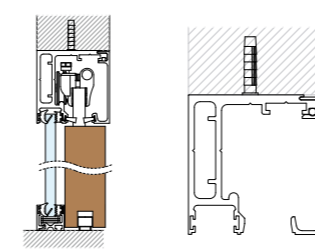
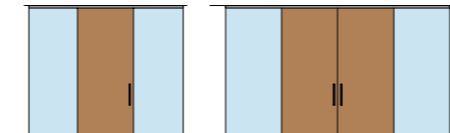

72 x 72 mm



Caratteristiche Tecniche

Technical features

 PORTATA Weight	150kg per porta / for door 330lbs
 SPESORE VETRO Glass thickness	10 ÷ 14 mm 3/8" to 9/16"
 SPESORE PORTA IN LEGNO Wooden door thickness	28 ÷ 50 mm 1 1/8" to 1 15/16"
 REGOLAZIONE IN ALTEZZA Height adjustment	3 mm 1/8"
 DISTANZA A PARETE Wall distance	22 mm 7/8"
 DISTANZA TRA ANTA E VETRO FISSO Distance between door and sidelight	15.4 ÷ 17.4 mm 5/8" to 11/16"

 INSTALLAZIONE A VETRO Glass installation	✓
 INSTALLAZIONE A FALSO SOFFITTO False ceiling installation	✓
 INSTALLAZIONE TRA PARETI Installation between walls	✓

 SOFTCLOSE Soft close	Doppio / Double		
 DIMENSIONI MINIME (doppio Softclose) Minimum dimensions (double soft close)	1010 mm 39 3/4"		
 RETAINER MECCANICO Mechanical retainer	Doppio / Double		
 DIMENSIONI MINIME (doppio Retainer) Minimum dimensions (double Retainer)	800 mm 31 1/2"		
 FINITURE Finishes	02 Ossidato naturale Natural oxidized	05 Ossidato nero Black oxidized	13 PVD simil inox similar PVD stainless steel



**CERTIFICAZIONE DURABILITÀ
CICLI CORROSIONE**
Durability certification
Corrosion cycles

DURABILITÀ (100.000 Cicli)
Durability (100.000 Cycles)

PESO DELLA PORTA (da 101 a 330 kg)
Door mass (from 101 up to 330 kg)

SICUREZZA (Grado 1 per tutti gli scorrevoli)
Safety (All sliding must be grade 1)

RESISTENZA ALLA CORROSIONE (Alta resistenza)
Corrosion resistance (High resistance)

CATEGORIA DELLA PORTA (Porta scorrevole)
Category of door (Sliding door)

FRIZIONE INIZIALE VALORE MASSIMO CONSENTITO (4% della massa)
Initial friction maximum permitted value (4% of the mass)

according to
EN1527

- 6 3 - 1 3 - 1 3

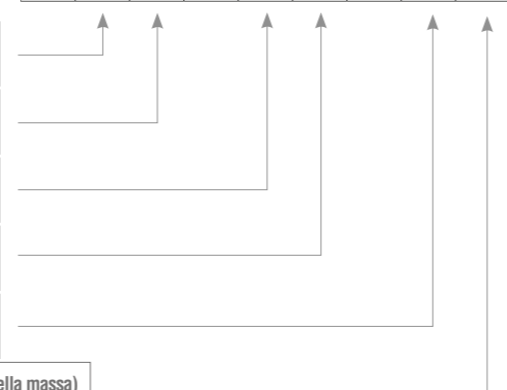

Configurazioni kit

Configurations kit

KB150CS0/3.2

• Kit scorrevole parete/soffitto con doppio soft-close.

• Sliding wall / ceiling kit with double soft-close

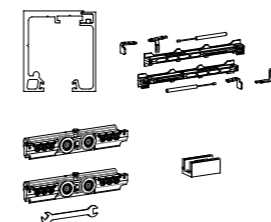

KB150SS0/3.2

• Kit scorrevole su vetro fisso con doppio soft-close.

• Sliding kit on fixed glass with double soft-close

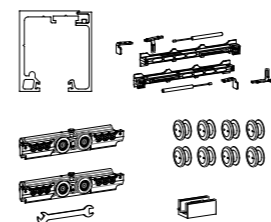

KB150FS0/3.2

• Kit scorrevole a soffitto con fisso, con doppio soft-close.

• Fixed sliding ceiling kit with double soft-close

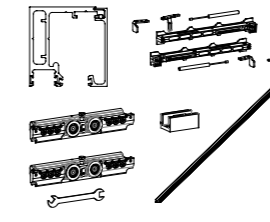

KB150CM0/3.2

• Kit scorrevole parete/soffitto con retainer e stop meccanico.

• Sliding wall / ceiling kit with retainer and mechanical stop

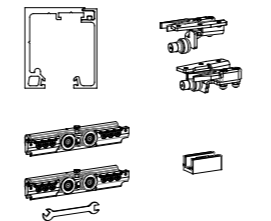

KB150SM0/3.2

• Kit scorrevole su vetro fisso con retainer e stop meccanico.

• Sliding kit on fixed glass with retainer and mechanical stop

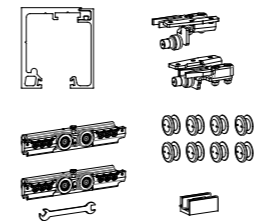

KB150CA0/3.2

• Kit scorrevole parete/soffitto con retainer e antishock.

• Sliding wall / ceiling kit with retainer and Antishock

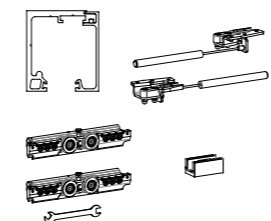

KB150SA0/3.2

• Kit scorrevole su vetro fisso con retainer e antishock.

• Sliding kit on fixed glass with retainer and Antishock

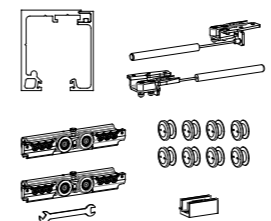

KB150FA0/3.2

• Kit scorrevole a soffitto con fisso, con retainer e antishock.

• Sliding ceiling kit with fixed, with retainer and Antishock

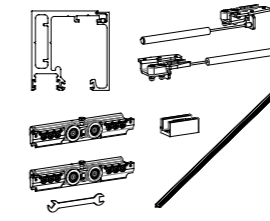

Profili

Profiles

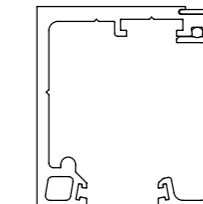

• Profili per scorrevole
- fissaggio a soffitto/parete.
Anche per porte in legno < 40mm

• Profiles for sliders
- fixed on ceiling/wall.
Anche per porte in legno < 40mm

B150EK00/2 2 m

B150EK00/3 3 m

B150EK00/3.2 3,2 m

B150EK00/4 4 m

B150EK00/6 6 m

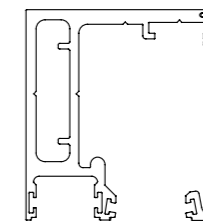

• Profili per scorrevole
- fissaggio a soffitto con vetro fisso.
- fissaggio a soffitto con fisso per porta in legno
- fissaggio a parete per porta in legno > 40mm

• Profiles for sliders
- fixed on ceiling with fixed glass
- fissaggio a soffitto con fisso per porta in legno
- fissaggio a parete per porta in legno > 40mm

B150EK01/2 2 m

B0150EK01/3 3 m

B150EK01/3.2 3,2 m

B150EK01/4 4 m

B150EK01/6 6 m

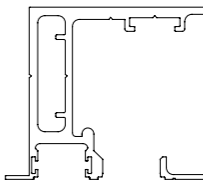

• Profili per scorrevole
- fissaggio a falso soffitto
- fissaggio a falso soffitto con vetro fisso.

• Kit profiles for sliders
- fixed on false ceiling
- fixed on false ceiling with fixed glass

*** B150EK02/2** 2 m

*** B0150EK02/3** 3 m

*** B150EK02/3.2** 3,2 m

*** B150EK02/4** 4 m

*** B150EK02/6** 6 m

* Disponibile da marzo 2021 - Available from March 2021

Kit pinze Clamps kit



B110EK10

- Kit coppia pinze con chiave
- Kit with Clamps and Key



B150EK3NN

- Kit coppia Retainer. Stop meccanico
- Kit with pair of mechanical stops



B150EK3AA

- Kit coppia Retainer + Antishock
- Kit with pair of mechanical stops and anti-shock feature



B150EK3SS

- Kit coppia Soft Close CPCS
- Kit with Soft Close CPCS pair



Tappi Caps



B150EP73

- Coppia di tappi
- Pair of caps



B150EP74

- Coppia di tappi forati
- Pair of perforated caps



B150EP75

- Coppia di tappi per versione con fisso laterale
- Pair of caps for model with side fixed glass



B150EP76

- Coppia di tappi forati per versione con fisso laterale
- Pair of perforated caps for model with side fixed glass

Accessori Accessories



B150EP64

- Spessore per Velella - senza vetro fisso
- Spacer for track - without fixed glass



B150EP65

- Spessore per Velella - con vetro fisso
- Spacer for track - with fixed glass



B150EP77

- Coppia supporti laterali
- Pair of side fittings



B150EP48

- Tassello di collegamento per vetro fisso
- Splice connector for fixed glass



B150EP85

- Kit accessorio per porte in legno
- Accessory kit for wooden doors



BF70

- Borchia per fissaggio barra a vetro
- Fitting for securing track to glassbar



B150EP27

- Perno per porte battenti da applicare ad estrusi Fluido+
- Spindle for swing doors, to be applied to Fluido+ profiles



BF50

- Guida a terra.
- Floor Guide

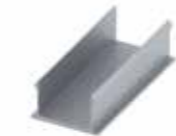

B150EP45

- Copertura lato fisso
- Cover fixed panel

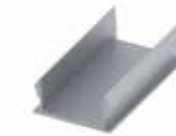

B150EP46

- Copertura lato porta
- Cover door side



SPZ-FP

- Guarnizione a spazzola in tessuto
- Fabric brush seal



SPZ-FPBL

FLUIDO+

Sistemas corredizos invisibles y compactos

Fluido+ 70, 110 y 150 son los nuevos sistemas correderos compactos para puertas en vidrio templado. Espacios oscuros ya pertenecen al pasado: las nuevas exigencias son transparencia y espacios amplios. La mecánica resistente de los sistemas Fluido+ se funde perfectamente con su diseño moderno, garantizando seguridad, privacidad y claridad. Diseñados para cumplir con las exigencias del mercado, son aptos para aplicaciones a pared, a techo y a falso techo. En la versión a falso techo el mecanismo está completamente escondido.

Características:

- Nuevo sistema de cierre progresivo – CPCS;
- Antichoque disponible;
- Ajuste frontal de la puerta sencillo y rápido;
- Capacidad hasta 150 kg;
- Enganche rápido entre riel y tapa;
- Disponible también para puertas de madera.

FLUIDO+

Systèmes coulissants invisibles et compacts

Fluido+ 70, 110 et 150 sont nos derniers systèmes coulissants compacts pour portes en verre trempé. Les murs sombres appartiennent au passé : les besoins modernes sont la clarté et les grands espaces. La mécanique résistante des systèmes Fluido+ se marie parfaitement avec leur design moderne, permettant sécurité, intimité et luminosité. Conçus pour répondre aux besoins du marché, ils conviennent aux installations au mur, au plafond et en faux plafond. Dans la version faux plafond, le mécanisme coulissant est complètement caché.

Caractéristiques:

- Nouveau système de fermeture progressive CPCS;
- Antichoc disponible ;
- Réglage frontal de la porte simple et rapide ;
- Capacité jusqu'à 150 kg ;
- Accouplement rapide du rail coulissant et du couvercle ;
- Disponible pour les portes en bois.

FLUIDO+

Unsichtbare und kompakte Schiebesysteme

Fluido+ 70, 110 und 150 sind unsere neuesten kompakten Schiebesysteme für Türen aus ESG Glas. Dunkle Wände gehören der Vergangenheit an: Moderne Bedürfnisse sind Klarheit und viel Platz. Die widerstandsfähige Mechanik von Fluido+ -Systemen passt perfekt zu ihrem modernen Design und ermöglicht Sicherheit, Privatsphäre und Helligkeit. Konzipiert, um den Marktanforderungen gerecht zu werden, eignen sie sich für Wand-, Decken- und Zwischendeckeninstallationen. In der Zwischendeckenversion ist der Schiebemechanismus vollständig verborgen.

Eigenschaften:

- Neues progressives CPCS-Schließsystem;
- Antischock verfügbar;
- Vordere Einstellung der Tür, einfach und schnell gemacht;
- Tragfähigkeit bis zu 150 kg;
- Schnelle Kopplung von Gleitschiene und Abdeckung;
- Verfügbar für Holztüren.



We Build the Invisible

Colcom Group S.p.A.

Tel. (+39)0302532008 - (+39)0302530289

Fax. (+39)0302534707

colcomgroup.it

Via degli Artigiani, n°56 int.1 - 25075 Nave (Brescia) - Italy

We Build the Invisible

